

Article number: 12717000140500

Description: KLEE-coil 717 000 140.500
M14 St. steel 1.4305

Measures

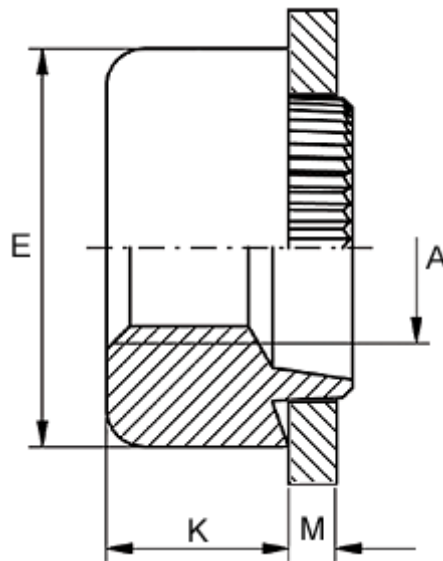

Female thread A	= M14
Height K	= 10.0
Outer diameter E	= 25.0
Plate thickness	= 4.7 to 4.9
Recommended bore diameter for extreme load	= 19.0
Recommended bore diameter for normal use	= 20.0